

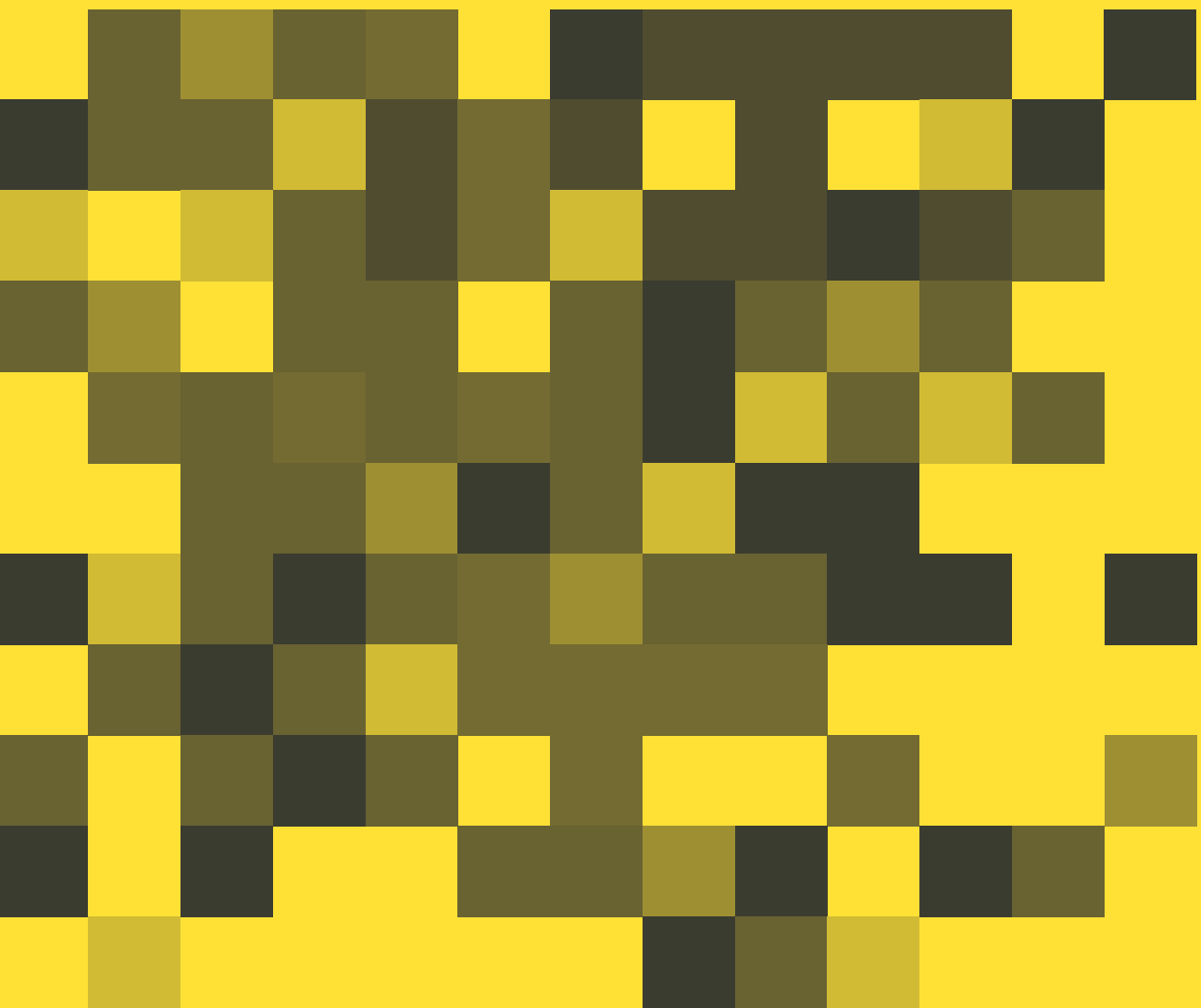

VECTOR INSTITUTE

APRIL 2020 – MARCH 2021

ANNUAL REPORT ↗



Contents

MESSAGE FROM THE BOARD CHAIR AND THE PRESIDENT AND CEO	3	TECHNOLOGY & AI ENGINEERING	31
RESEARCH	6	THOUGHT LEADERSHIP: BRIDGING AI WITH SOCIETAL AND ECONOMIC IMPACT	32
AI FOR INDUSTRY	16	OPERATIONS	34
TALENT AND WORKFORCE DEVELOPMENT	22	FINANCIALS	35
HEALTH	28	TEAM AND LEADERSHIP	37

MESSAGE FROM THE BOARD CHAIR AND THE PRESIDENT AND CEO

Our Three-Year Strategy kicked off just as Ontario was heading into lockdown.

As the COVID-19 pandemic took hold, we were faced with a test: How would we maintain research productivity, propagate AI application, and develop the AI workforce?

Meanwhile, government, business, and health leaders were calling. They wanted to know how AI could help. The Vector Institute had established a web of world-leading AI experts that touched most areas in Canada where AI learning and application took place. Surely it could lend its expertise?

The pandemic tested our society and institutions' ability to rally a response and underscored AI expertise as an underpinning of Canada's social and economic objectives.

Indeed, Vector's community responded. In a year of grave loss, the enterprising and compassionate spirit of the Vector community was a bright spot.

It is a credit to our entire community — researchers, students, staff, universities, businesses, governments, and health partners — that Vector's annual report is as substantial as it is this year. While it is not filled with photographs, you will see a remarkable array of accomplishments. That our offices were closed for about 60 per cent of the year and nearly a third of our team was new and had never met in person did not slow us down.

The first indicator of our community's resilience was that compute usage was largely uninterrupted as we pivoted to a virtual work environment — a reflection of research productivity.

Next, we addressed our industry sponsors' most urgent AI challenges and skills gaps by offering our full suite of applied AI programs and projects online, enabling record participation. With hands-on experience, one such project taught industry professionals new techniques for correcting dataset shift — the term used to describe major changes in datasets that impact the accuracy of an AI model's predictions — caused by big events such as a pandemic.

When Ontario sought to leverage AI for its pandemic response, we accelerated efforts by diverting high-performance compute equipment to the Ontario Health Data Platform (OHDP) that is now powering research on topics like disease outcomes, hospitalization rates, and social inequities. To be sure, the pandemic expedited critical research access to health data for innovative AI analysis and applications. For example, with technical support from Vector and Unity Health Toronto St. Michael's Hospital, a secure computing environment has been developed to enable 30 Ontario hospitals to contribute data for AI research to drive system-wide health insights.

Individual research groups also responded, using AI to study phenotyping of the virus and CT images, and supporting initiatives like #Howsmyleftening, a centralized data analytics and visualization hub for monitoring contagion.

But for an institute whose *raison d'être* is to recruit talent to Canada and develop the AI workforce, our greatest challenge was addressing the pandemic's chilling effect on hiring, travel, and visa applications. We mitigated these impacts by funding virtual

research internships that otherwise would have been cancelled, hosting curated online recruitment events for Canadian employers, and offering dedicated career services for students and new graduates. Hiring and recruitment are rebounding and our talent community continues to grow, but there is no question that this will remain our top priority in the near term.

And as we grow our community, diverse representation will be top of mind. Our community's drive to bring its talent to bear to build a better society is humbling and inspiring. This was no more true than when events in the US and Canada shone a spotlight on social injustices. Black and Indigenous communities are underrepresented in STEM, and the field of AI is no exception. We are deeply grateful for the brave and selfless work of the volunteer committee that presented recommendations for improving equity, diversity, and inclusion at Vector, and for the generous donations towards a challenge fund that will provide additional support to Black and Indigenous students pursuing internships at Vector.

We are reminded that the very technology we develop can perpetuate and exacerbate biases, making our commitment to responsible AI as important as ever. To this end, our new AI Engineering Team, together with the Schwartz Reisman Institute for Technology and Society, is contributing local and international thought leadership; the team is meeting with businesses, governments, and hospitals to share practical insights on AI governance and develop open source tools to enable responsible AI adoption. Additionally, in partnership with the National Research Council of Canada Industrial Research Assistance Program, we are proud to have launched a new course

that teaches small and medium-sized enterprises (SMEs) how to identify and root out biases in their data. And, further validating the importance of the OHDP, researchers initiated projects that analyze ethno-racial data to understand the disparate impacts of the pandemic.

So, as we begin to emerge from the pandemic, we feel at once sombre and emboldened.

We were able to respond substantively and deliver on our mandate because — together with our federal and provincial partners, industry sponsors, and institutional partners — we had already established an expansive and well-connected foundation of AI researchers and practitioners.

As we look toward our fifth year as an institute, we will amplify our research impact with tools for broad AI application, continue to grow our research community, ensure Ontarians benefit from the best available innovations in health, and help Canadian companies become global competitors using AI. Importantly, we will significantly expand our programming for SMEs, the lifeblood of our economy.

The world has changed, but our focus and confidence have not. Our relentless pursuit of the national vision for responsible AI that benefits all Canadians continues.

With gratitude and optimism,

Garth Gibson

President & CEO



Ed Clark

Chair of the Board of Directors



OUR VISION

The Vector Institute will drive excellence and leadership in Canada's knowledge, creation, and use of AI to foster economic growth and improve the lives of Canadians.

OUR MISSION

We will lead Ontario's efforts to build and sustain AI-based innovation, growth, and productivity in Canada by focusing on the transformative potential of deep learning and machine learning.

We, together with our AI partners in other parts of Canada, will work with Canadian industry and public institutions to ensure that they have the people, skills, and resources to be best in class at the use of AI.

We will support Canada's innovation clusters in AI and focus on helping startups grow to become Canadian-based global leaders.

We will attract the best global talent focused on research excellence; our researchers and academic partners will be part of a vibrant community of innovative problem-solvers, working across disciplines on both curiosity-driven and applied research.

OUR THREE-YEAR STRATEGY

Designed with input from researchers, industry, public institutions, and other stakeholders, Vector's Three-Year Strategy (2020-2023) expands successful programs with new initiatives related to AI talent, commercialization, and application, and leads Canada towards the responsible and effective use of AI.

The strategy comprises four pillars:

1. Become a top 10 world-leading centre for machine learning and deep learning research.
2. Expand partnerships with Canadian industry through programs for talent, training, and applied AI projects.
3. Enable effective and appropriate research access to health data towards better whole-life health.
4. Contribute thought leadership about Ontario and Canada's role in AI, including economic and societal impacts.

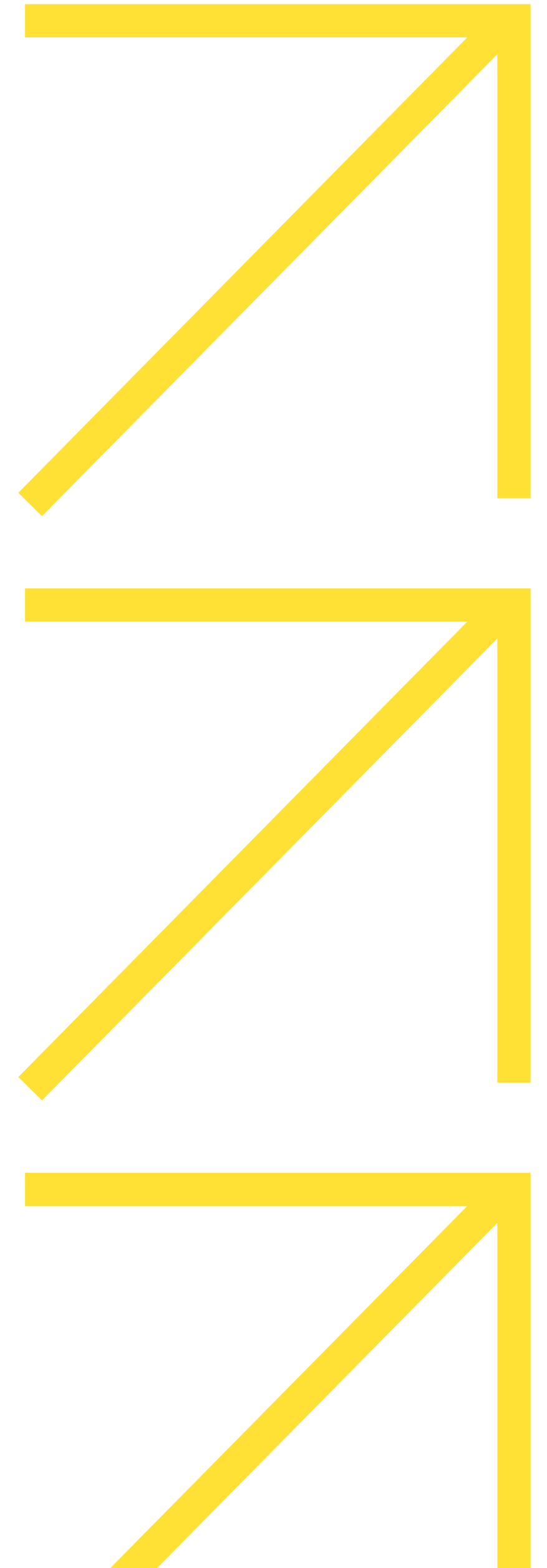

RESEARCH

617

Members of Vector's research community, including Faculty Members, Faculty Affiliates, Postgraduate Affiliates, graduate researchers, Postdoctoral Fellows, and undergraduates

2

New Faculty Members

72

New Faculty Affiliates

4

New Canada CIFAR AI Chairs at Vector

30

New Postgraduate Affiliates

293

Papers published in global conferences and journals

74

Research events and talks hosted, plus seven reading groups

Growing our research strengths

Attracting, retaining, and training AI talent is core to Vector's mission. In a year consumed by the global pandemic, we continued to grow our world-leading research community. What was once a handful of founding faculty has matured into a research community of 617 members representing 23 universities across Canada, including 136 faculty, 45 Postdoctoral Fellows, 245 PhDs, 101 master's students, and 90 undergraduate students.

We continue to drive this growth amid intensifying global competition for research talent through new and expanding efforts to attract and develop an outstanding community. Highlights of these efforts include:

- Building bridges between industry and research to facilitate productive connections between leading research and AI application.
- Creating more ways for junior researchers to get involved with our industry sponsors and the health sector to work on real-world problems and novel data sets.
- Expanding access to events focused on research and applications, fostering opportunities for collaboration, and increasing online access to internships.
- Amplifying researchers' capabilities and capacity to lead outstanding world-class research by expanding access to Vector's scientific computing resources.

We've achieved these accomplishments amid a global pandemic, during which we offered uninterrupted access to high-performance computing resources and avoided interruptions to research productivity by successfully pivoting to virtual research, events, and collaborations. For example, we expanded online internship programs to compensate for cancelled local university internships and research programs, and hosted our annual two-day Research Symposium virtually.

As we grow our research strengths, we aim to make Vector a top 10 global centre for machine learning and deep learning research, and to continue attracting leading scientists and top students to Toronto, Ontario, and Canada.

26 remote
Vector
internships
supported
16 Canadian
research labs.

SPOTLIGHT ON RESEARCH

Vector Faculty Members Leading Research in Five Key Areas

In spite of the challenges of the COVID-19 pandemic, Vector researchers pushed the boundaries of machine learning and deep learning. Here are examples of Vector Faculty Members leading work in the five research focus areas identified in Vector's Three-Year Strategy.



Health

ANNA GOLDENBERG

AI for health offers huge potential to drive improvements in health care systems and patient outcomes. Anna is leading thoughtful research into what it will take for AI to produce actionable, reliable, and trustworthy decisions that have a substantial impact on the health system and delivery of care. Her projects range from developing tools to detect COVID-19 in the broader population with the help of wearables to a collaboration with clinicians at The Hospital for Sick Children (SickKids) detecting real time deterioration of patients in ICU for the prevention of critical events.



Sequential Decision-Making

ANIMESH GARG

Animesh is building Algorithmic Foundations for Generalizable Autonomy. His research focuses on machine learning algorithms for perception and control in robotics. He aims to enable Generalizable Autonomy through efficient robot learning for long-term sequential decision making. The principal technical focus lies in understanding representations and algorithms to enable simplicity and generality of learning for interaction in autonomous agents. He actively works on applications of robot manipulation in industrial and health care robotics.

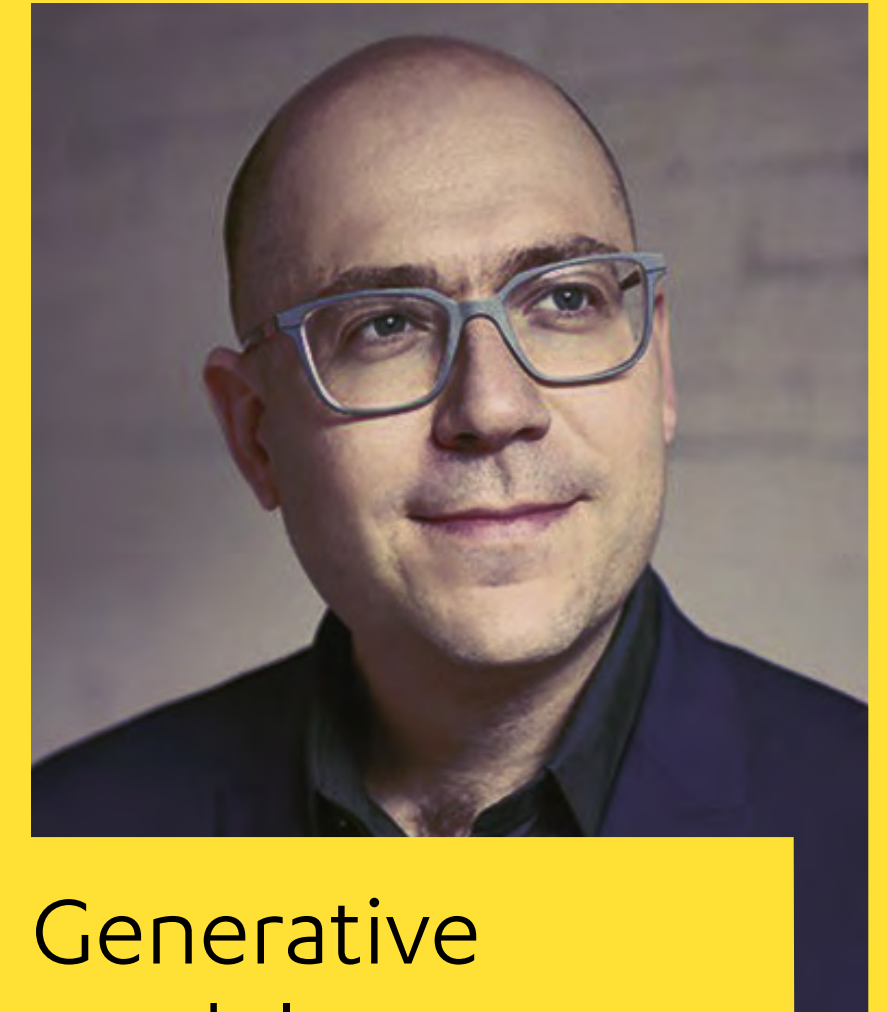

Generative Models

ALÁN ASPURU-GUZIK

Alán is using new technologies, such as quantum computing, machine learning, and automation to accelerate the discovery of new chemicals and materials that are useful to society.

SPOTLIGHT ON RESEARCH



Machine Learning and AI Theory

DAN ROY

Our understanding of deep learning is largely empirical thus far. Without a theoretical basis, we cannot reliably deploy systems with confidence they will perform as expected. Dan's team is at the forefront of research on mathematical theories of deep learning. Using tools from learning and information theory, his research team has made major advances in understanding the statistical properties of deep learning. His team has also made recent advances on optimal prediction in changing environments and understanding neural networks as they grow large in both width and depth.



Security, Privacy, and Fairness

TONIANN (TONI) PITASSI

Toni's research advances fairness in AI by developing broader definitions of fairness that incorporate domain-specific information, as well as traditional notions of bias and fairness from fields of law and philosophy.

TONIANN PITASSI RECEIVES THE 2021 EATCS AWARD

In March 2021, the European Association for Theoretical Computer Science (EATCS) Awards Committee selected Vector Faculty Member and Canada CIFAR AI Chair Professor Toniann (Toni) Pitassi (University of Toronto) as the recipient of the prestigious 2021 EATCS Award for her significant contributions to computational complexity. The EATCS Awards Committee noted that Toni's contributions have transformed the field of computational complexity and neighbouring areas of theoretical computer science, and will continue to have a lasting impact. This award is only the latest of Toni's long list of laudable accomplishments. In 2018, Toni was named as an Association of Computer Machinery (ACM) Fellow, in recognition for contributions to research and education in the areas of computational and proof complexity.

New Faculty Members

In 2020-21, Vector welcomed two new Faculty Members:



Michael Brudno is a professor in the Department of Computer Science at the University of Toronto, and Chief Data Scientist at the University Health Network (UHN). He is also Scientific Director of HPC4Health, a secure health sector computing cloud in Ontario. Michael's research focuses on developing computational methods for the analysis of clinical and genomic datasets, especially the capture of precise clinical data from clinicians using effective user interfaces, and its use in the automated analysis of genomes. Michael received his PhD from the Computer Science Department of Stanford University, working on algorithms for whole genome alignments. He completed a postdoctoral fellowship at UC Berkeley and was a Visiting Scientist at MIT. He received the Ontario Early Researcher Award and the Sloan Fellowship, as well as the Outstanding Young Canadian Computer Scientist Award.

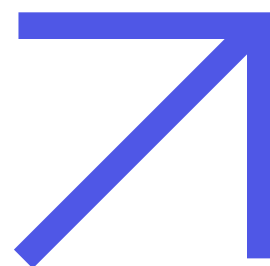

Rahul G. Krishnan is a professor in the Department of Computer Science and the Laboratory for Microbiology and Pathology at the University of Toronto. Rahul's research centres on using machine learning to accelerate advances in health care. By blending ideas from Bayesian networks, probabilistic inference, causal inference, and deep learning, Rahul seeks to develop practical machine learning models for use in clinical decision support tools. Rahul received his PhD in Electrical Engineering and Computer Science from MIT. Rahul was a NeurIPS Top 400 Reviewer in 2019 and 2020, and has earned the Henning Biermann Award from New York University and a Pearson International Scholarship from the University of Toronto.

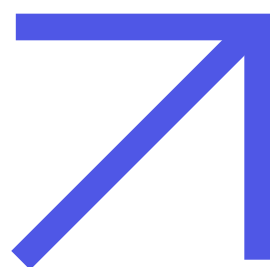
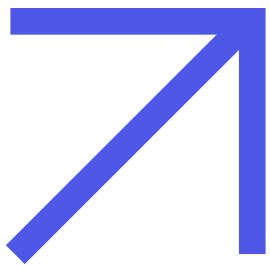

Canada CIFAR AI Chairs 2020-21

The Canada CIFAR AI Chairs program is a cornerstone of the Pan-Canadian AI Strategy, which aims to attract and retain outstanding researchers to Canada by providing them with long-term, dedicated funding to pursue innovative ideas. Candidates for the program are reviewed by an International Scientific Advisory Committee comprising scientific leaders from both top institutions and companies.

In 2020-21, four Vector Faculty Members were awarded Canada CIFAR AI Chairs, joining a growing community of Vector Faculty Members who have been named since the launch of the Pan-Canadian AI Strategy.

- **Michael Brudno**, University Health Network, University of Toronto
- **David Duvenaud**, University of Toronto
- **Rahul G. Krishnan**, University of Toronto
- **Richard Zemel**, University of Toronto

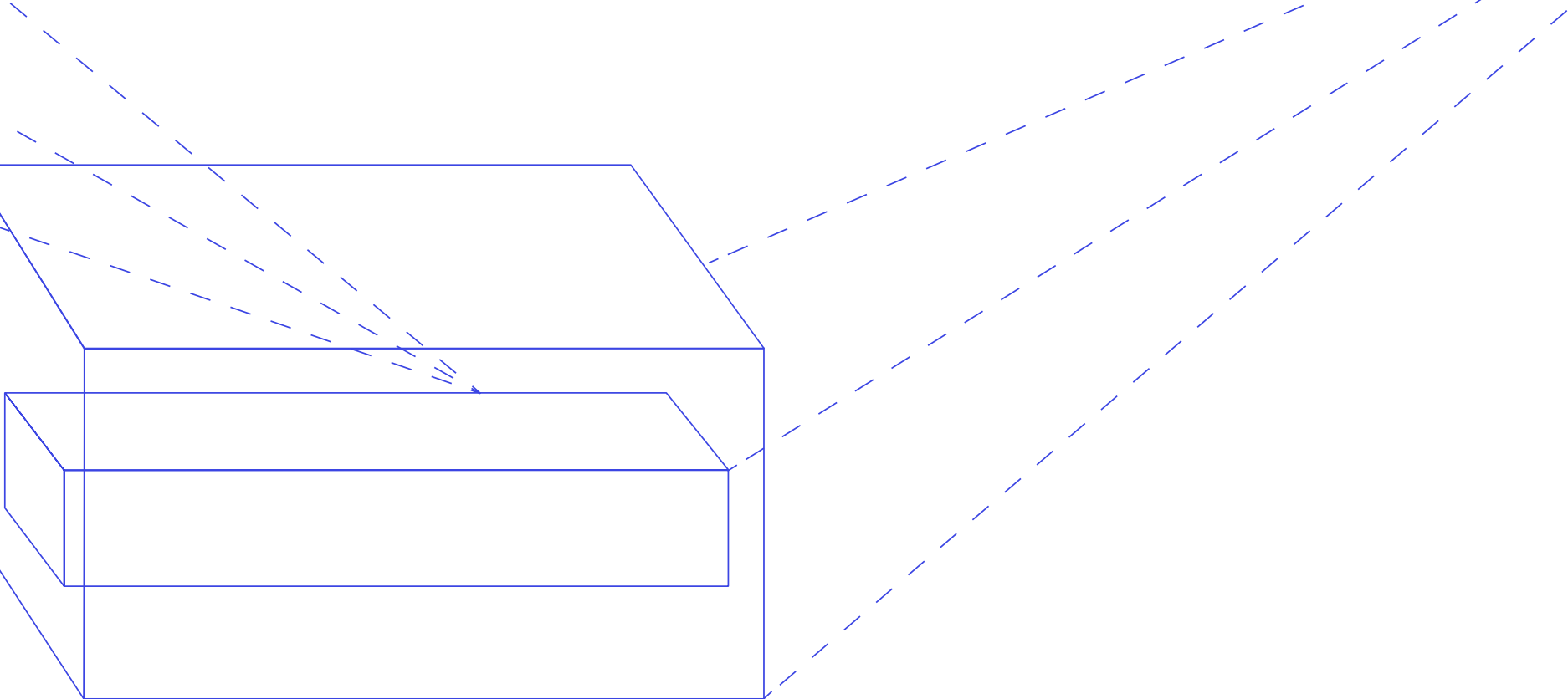

Canada CIFAR AI Chairs at Vector Institute

- **Alán Aspuru-Guzik**, University of Toronto
- **Jimmy Ba**, University of Toronto
- **Shai Ben-David**, University of Waterloo
- **Michael Brudno**, University of Toronto
- **Juan Felipe Carrasquilla**, Vector Institute
- **David Duvenaud**, University of Toronto
- **Murat A. Erdogdu**, University of Toronto
- **Amir-massoud Farahmand**, Vector Institute
- **Sanja Fidler**, University of Toronto
- **David Fleet**, University of Toronto Scarborough
- **Jakob Foerster**, University of Toronto Scarborough
- **Animesh Garg**, University of Toronto
- **Marzyeh Ghassemi**, University of Toronto
- **Anna Goldenberg**, Hospital for Sick Children
- **Roger Grosse**, University of Toronto
- **Rahul G. Krishnan**, University of Toronto
- **Chris Maddison**, University of Toronto
- **Alireza Makhzani**, Vector Institute
- **Sheila McIlraith**, University of Toronto
- **Quaid Morris**, University of Toronto
- **Sara Mostafavi**, University of British Columbia
- **Sageev Oore**, Dalhousie University
- **Nicolas Papernot**, University of Toronto
- **Gennady Pekhimenko**, University of Toronto
- **Toniann Pitassi**, University of Toronto
- **Pascal Poupart**, University of Waterloo
- **Daniel Roy**, University of Toronto
- **Frank Rudzicz**, Li Ka Shing Knowledge Institute, Unity Health St Michael's Hospital and University Health Network
- **Angela Schoellig**, University of Toronto
- **Leonid Sigal**, University of British Columbia
- **Graham Taylor**, University of Guelph
- **Bo Wang**, University of Toronto
- **Richard Zemel**, University of Toronto

Faculty Affiliates 2020-21

In December 2020, Vector welcomed 72 Faculty Affiliates holding appointments at 15 institutions and universities across Ontario. The 2020 cohort is a combination of 27 new members and 45 renewals. An additional 29 Faculty Affiliates appointed in 2019 will also continue to complete the two-year term of their appointments.

The Vector Faculty Affiliates Program brings together leading researchers from across Ontario to expand the community's expertise in the areas of AI, computer science, engineering, and other disciplines related to machine learning, as well as strategic domains of application. Vector Faculty Affiliates are appointed for a two-year term and form an integral part of the Vector community, engaged in both research and community activities.

Where interests align, Faculty Affiliates also collaborate with industry sponsors, as well as health and academic partners, through participation in networking events, seminars, training sessions, and workshops.

Ajay Agrawal, University of Toronto

Benjamin Alarie, University of Toronto

Ashton Anderson, University of Toronto

Hassan Ashtiani, McMaster University

Suzanna Becker, McMaster University

Vaughn Betz, University of Toronto

Ben Blencowe, University of Toronto

Yuri Boykov, University of Waterloo

Marcus Brubaker, York University

Neil Bruce, University of Guelph

Kieran Campbell, Lunenfeld-Tanenbaum
Research Institute

John Connolly, McMaster University

V. Radu Craiu, University of Toronto

Mark Daley, Western University

Konstantinos Derpanis, Ryerson University

Sven Dickenson, University of Toronto

Thomas Doyle, McMaster University

James Elder, York University

Melike Erol-Kantarci, University of Ottawa

Benjamin Fine, University of Toronto

Ali Ghodsi, University of Waterloo

Avi Goldfarb, University of Toronto

Jessica Gronsbel, University of Toronto

Maura Grossman, University of Waterloo

Yuhong Guo, Carleton University

Gillian Hadfield, University of Toronto

Benjamin Haibe-Kains, University of Toronto

Jesse Hoey, University of Waterloo

Michael Hoffman, University of Toronto

Ting Hu, Queen's University

Ihab Ilyas, University of Waterloo

Alec Jacobson, University of Toronto

Hui Jiang, York University

Alistair Johnson, Hospital for Sick Children

Gautam Kamath, University of Waterloo

Nachiket Kapre, University of Waterloo

Jonathan Kelly, University of Toronto

Elias B. Khalil, University of Toronto

Farzad Khalvati, University of Toronto

Kyros Kutulakos, University of Toronto

Kate Larson, University of Waterloo

Vianey Leos Barajas, University of Toronto

David Lie, University of Toronto

Jimmy Lin, University of Waterloo

Anne Martel, Sunnybrook Research Institute

Roger Melko, University of Waterloo

Alex Mihailidis, University of Toronto

Andreas Moshovos, University of Toronto

Anthony Niblett, University of Toronto

Mihai Nica, University of Guelph

Aleksandar Nikolov, University of Toronto

Anna Panchenko, Queen's University

Vardan Papyan, University of Toronto

Gerald Penn, University of Toronto

Laura Rosella, University of Toronto

Reza Samavi, Ryerson University

Scott Sanner, University of Toronto

Bhavin Shastri, Queen's University

Karan Singh, University of Toronto

Stephen L. Smith, University of Waterloo

Ranil Sonnadara, McMaster University

Suzanne Stevenson, University of Toronto

Babak Taati, University Health Network

Hamid Reza Tizhoosh, University of Waterloo

Ruth Urner, York University

Olga Veksler, University of Waterloo

Nandita Vijaykumar, University of Toronto

Yang Xu, University of Toronto

Yimin Yang, Lakehead University

Albert Yoon, University of Toronto

Fattane Zarrinkalam, University of Guelph

Joel Zylberberg, York University

Postgraduate Affiliates 2020-21

Established in 2018, the Postgraduate Affiliates program promotes engagement and collaboration among researchers in the AI community who are in the early stages of their careers.

Vector welcomed 30 Postgraduate Affiliates in 2020-21, comprising graduate researchers and Postdoctoral Fellows from universities and institutions across Ontario. Their research areas span core machine learning, neuroscience, health, computational linguistics, natural language processing, computational biology, computer vision, fairness, photonics for AI, systems, and how people relate to and understand AI. They join the 16 Postgraduate Affiliates who were selected in 2020 and are completing the two-year term of their appointments.

- **Morteza Babaie**, University of Waterloo
- **Aaron Babier**, University of Toronto
- **Gabriel Benigno**, Western University
- **Jason Bernard**, McMaster University
- **Hillary Dawkins**, University of Guelph
- **Ali Hadizadeh**, University of Toronto
- **Vinyas Harish**, University of Toronto
- **Amirul Islam**, Ryerson University
- **Shivam Kalra**, University of Waterloo
- **Matthew Kowal**, Ryerson University
- **Ruofan Liang**, University of Toronto
- **Bicky Marquez**, Queen's University
- **Evi Micha**, University of Toronto
- **Jonathan Michaels**, Western University
- **Parsa Mirdehghan**, University of Toronto
- **Mina Mirjalili**, University of Toronto
- **Bonaventure Molokwu**, University of Windsor
- **Jingcheng Niu**, University of Toronto
- **Danica Pawlick-Potts**, Western University
- **Anastasiia Razdaibiedina**, University of Toronto
- **Sean Robertson**, University of Toronto
- **Pritam Sarkar**, Queen's University
- **Alina Selega**, Lunenfeld-Tanenbaum Research Institute, Sinai Health System
- **Nicholas Sharp**, University of Toronto and Fields Institute for Research in Mathematical Sciences
- **Sriram Ganapathi Subramanian**, University of Waterloo
- **Hughes Thomas**, University of Toronto
- **Pashootan Vaezipoor**, University of Toronto
- **Sonia Yasmin**, Western University
- **Jason Yu**, York University
- **Helen Zhu**, University of Toronto

VECTOR EXPANDS ACCESS TO ADVANCED COMPUTING RESOURCES

This year we piloted a new initiative to expand access to our scientific computing clusters. The expanded access, rolling out in 2021-22, will enable more than 100 Faculty Affiliates and additional Postdoctoral Fellows and graduate researchers working with Faculty Affiliates to advance their research programs and will replace the Postgraduate Affiliate program going forward, as Vector's community has grown considerably since 2017.

Research Achievement and Award Highlights

FACULTY MEMBERS

Alán Aspuru-Guzik

- 26th Shih-I-Pai Distinguished Lecturer, University of Maryland

Murat Erdogdu

- CIFAR AI Catalyst Grant 2020-21

Sanja Fidler

- CIFAR AI Catalyst Grant 2020-21

Animesh Garg

- Outstanding Paper Award, ICML 2020 Workshop on Object Oriented Learning
- AAAI 2021 New Faculty Highlights Invited Speaker

Marzyeh Ghassemi

- CIFAR Azrieli Global Scholar

Roger Grosse

- Sloane Fellowship

Chris Maddison

- CIFAR AI Catalyst Grant 2020-21

Sheila McIlraith

- Best Paper Award KR2ML Workshop at NeurIPS 2020
- World's 50 Most Renowned Women in Robotics

Sageev Oore

- CIFAR AI Catalyst Grant 2020-21

Nicolas Papernot

- CIFAR AI Catalyst Grant 2020-21
- Connaught New Researcher Award

Gennady Pekhimenko

- ISCA Hall of Fame - ACM/IEEE MICRO Top Picks
- HiPEAC 2020 Paper Award
- Amazon AWS Machine Learning Research Award
- Facebook Faculty Research Award

Toniann Pitassi

- European Association for Theoretical Computer Science (EATCS) Award

Frank Rudzicz

- ClinicalNLP at EMNLP2020 Best Paper Award
- eTELEMED Best Paper Award

Angela Schoellig

- Alexander von Humboldt Professorship
- First Place and Overall 3-Year Winner in the AutoDrive Challenge
- Selected to compete in the AutoDrive Challenge II (2021-2025)

Leonid Sigal

- Killam Accelerator

Bo Wang

- CIFAR AI Catalyst Grant 2020-21

FACULTY AFFILIATES

Marcus Brubaker

- Top Reviewer, ICML 2020

Radu Craiu

- Fellow of the Institute of Mathematical Statistics (2020)

James Elder

- People's Choice Award at the 2020 VISTA Innovation & Technology Symposium (2020)

Melike Erol-Kantarci

- Distinguished Service Award of the IEEE Communications Society, Technical Committee on Green Communications and Computing (2020)

Yuhong Guo

- Best Paper Award, TASK-CV Workshop at ECCV

Ihab Ilyas

- ACM Fellow (2020)

Alec Jacobson

- ACM Fellow (2020) and NeurIPS Top 10 per cent Reviewer (2020)

Nisarg Shah

- AI's 10 to Watch, IEEE Intelligent Systems (2020)

Bhavin Shastri

- International Union of Pure and Applied Physics (IUPAP) Young Scientist Prize in Optics (2020)

Florian Shkurti

- Best Paper Award, RSS, Self-Supervised Robot Learning Workshop (2020)

Yu Sun

- CSME Mechatronics Medal (2021)
- Connaught Innovation Award (2021)
- NSERC Synergy Award for Innovation (2021) and Outstanding Editor Award by Microsystems & Nanoengineering (Springer Nature), (2020)



ADVANCING NEW IDEAS

Continuing his pioneering work in deep learning, Vector Chief Scientific Advisor Geoffrey Hinton published a new paper in February 2021 entitled *How to represent part-whole hierarchies in a neural network*, in which he describes an idea he calls GLOM that explores how a neural network with a fixed architecture can parse an image into a part-whole hierarchy which has a different structure for each image.

SPOTLIGHT

on Rising Talent

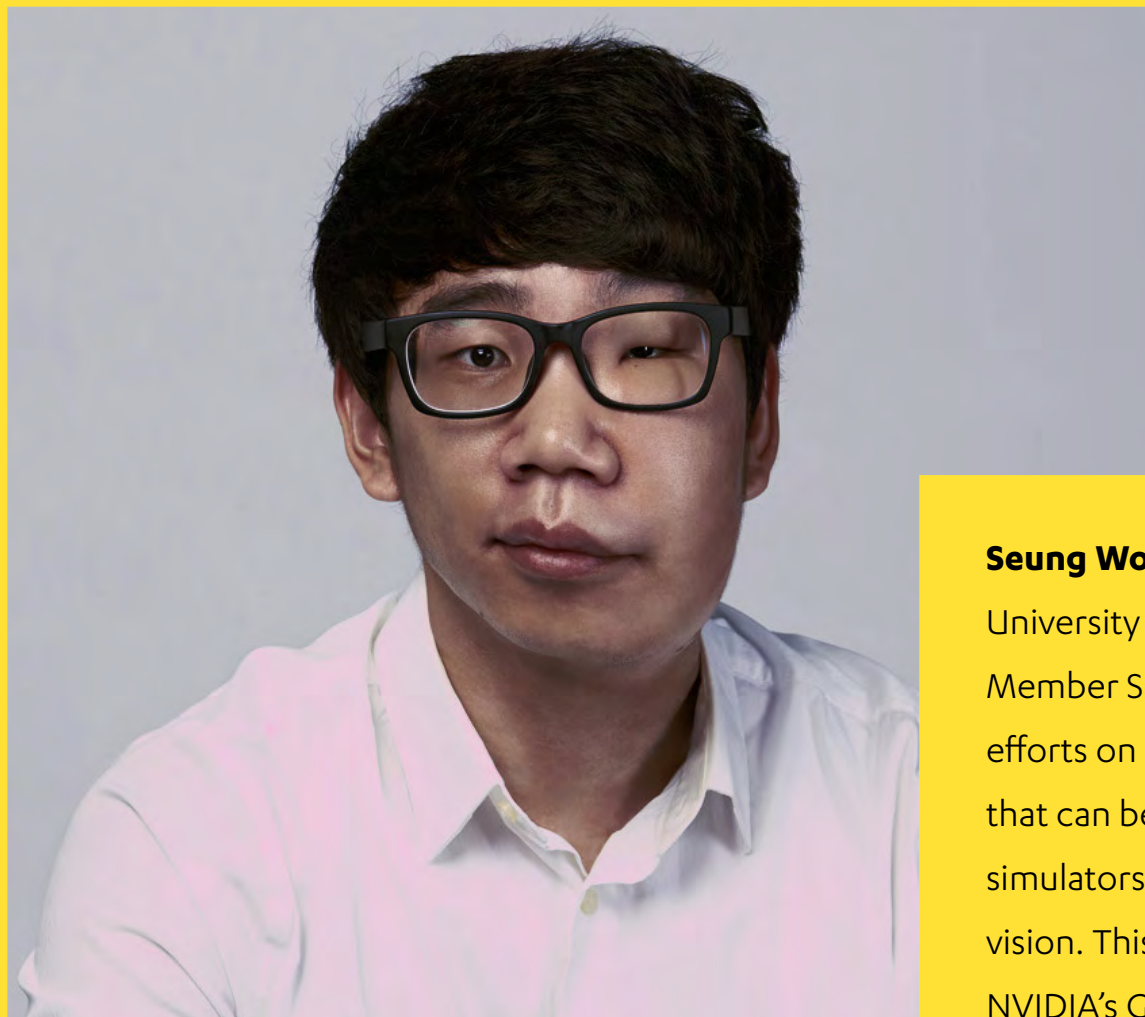

Seung Wook Kim is a PhD student at the University of Toronto working with Vector Faculty Member Sanja Fidler. Seung focuses his research efforts on data-driven neural network simulators that can be an alternative scalable way of building simulators, and generative models in computer vision. This year, Seung's research resulted in NVIDIA's GameGAN project — the first neural network model that mimics a computer game engine by harnessing generative adversarial networks (GANs).

"I believe Vector is one of the greatest places to study machine learning right now. At Vector, students can work on cutting-edge research problems with world-class faculty members and brilliant students, not to mention its enormous computing resources."

— **Seung Wook Kim, PhD student and research scientist, NVIDIA**

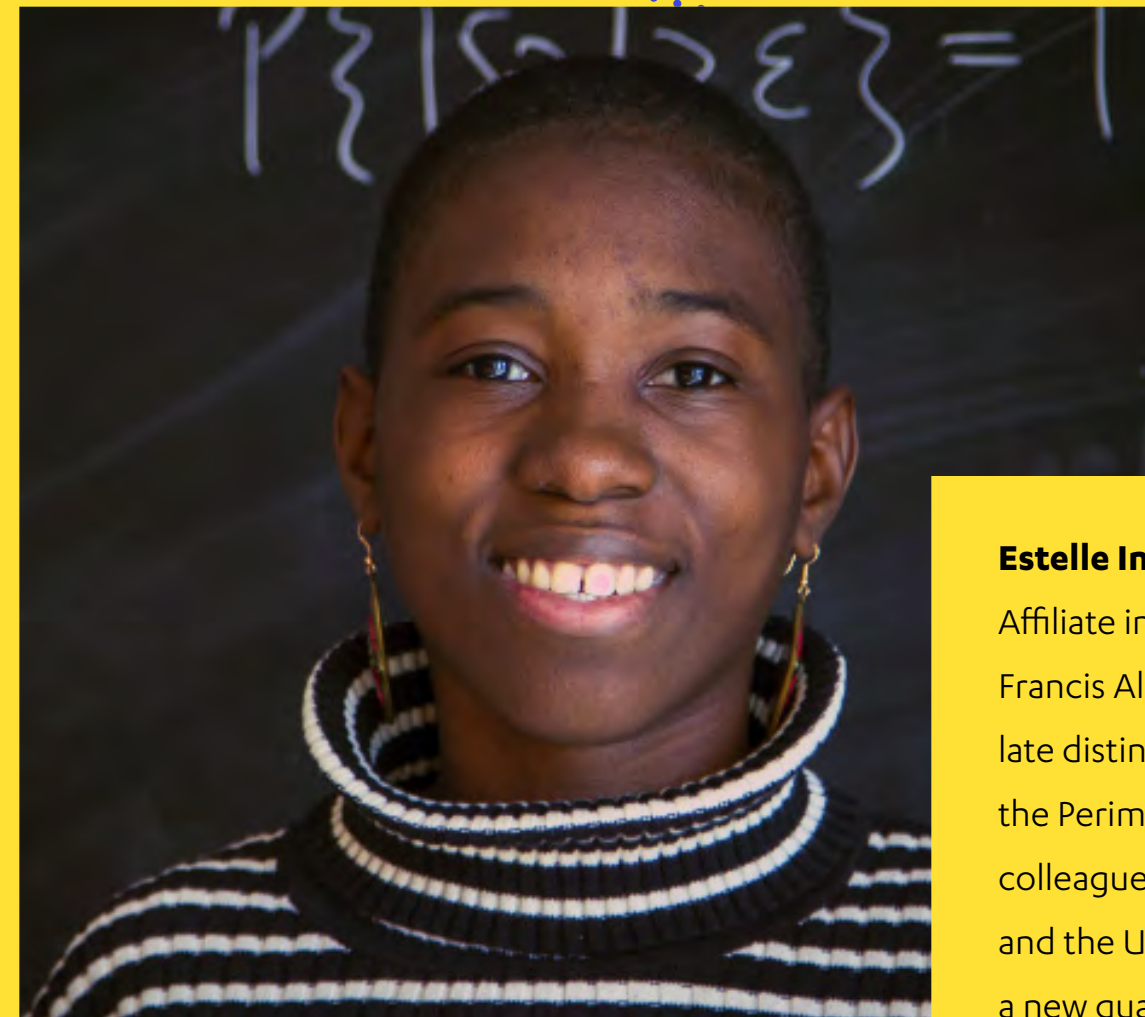

Estelle Inack joined Vector as a Postgraduate Affiliate in 2020. Estelle is the first recipient of the Francis Allotey Fellowship, which honours the late distinguished Ghanaian mathematician, at the Perimeter Institute in Waterloo. Working with colleagues from Vector, the Perimeter Institute, and the University of Waterloo, Estelle designed a new quantum-inspired algorithm that simulates classical and quantum annealing using artificial neural networks to solve complex optimization problems. Estelle is now working to develop commercial opportunities for quantum intelligent products and neural annealing.

"Through Vector, I came to develop an entrepreneurial mindset. My interaction with Vector's Industry Innovation team has resulted in me actually setting out to commercialize my research."

— **Estelle Inack, Vector Postgraduate Affiliate**

AI FOR INDUSTRY

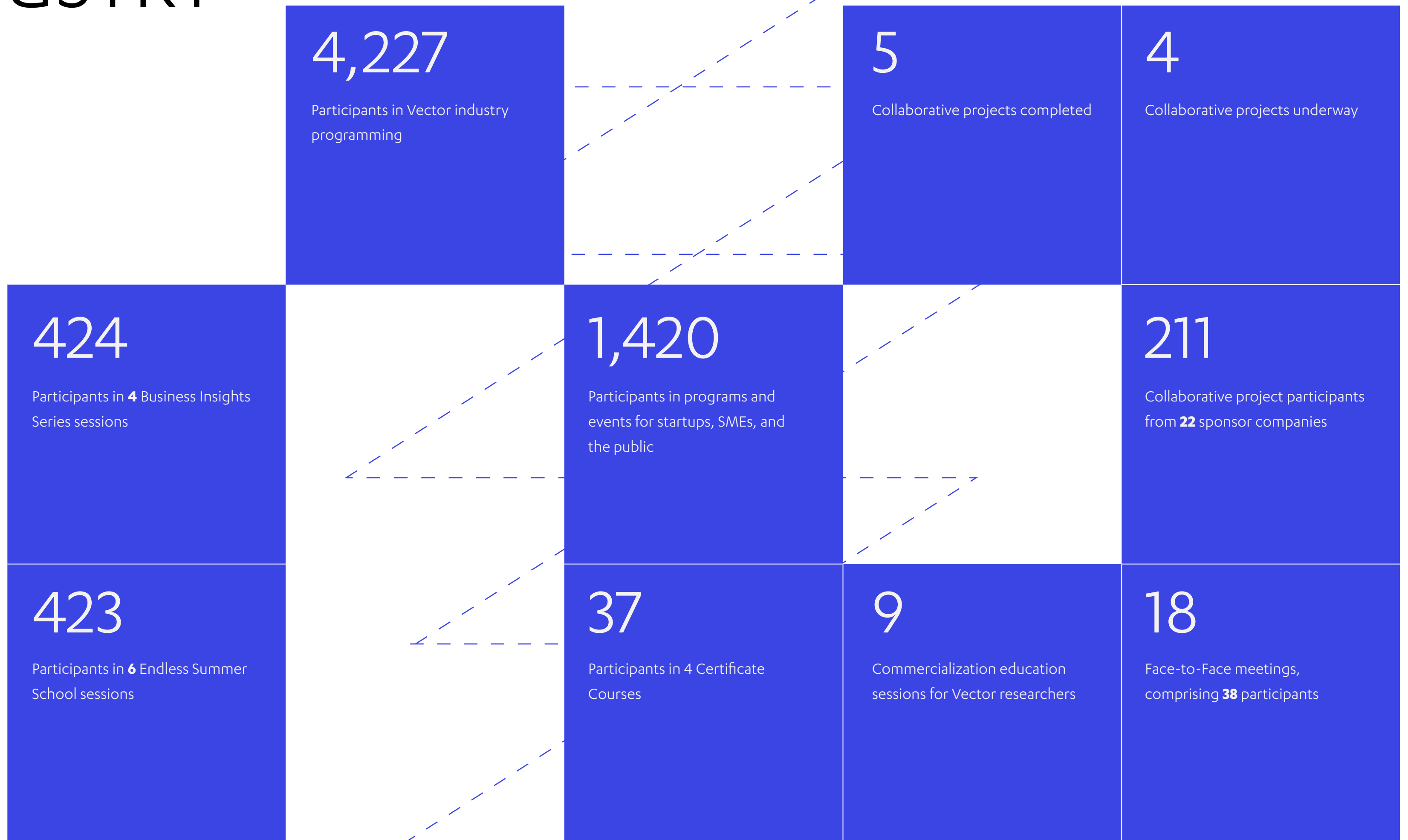

AI for Industry

Vector is more than a research institute. Core to our mandate is ensuring companies become world-leaders in applying AI to help them compete. Companies view Vector as a trusted source of truth and expertise, helping them improve their AI capabilities in four key ways:

- First-in-line access to talent for internal AI projects;
- Upskilling, insights and knowledge transfer that improves products and processes;
- Collaboration on applied AI projects that address industry-level frameworks and large-scale societal problems, and;
- Access to cutting-edge AI research driven by some of the world's brightest minds in machine learning and deep learning.

In our first few years as an institute, our teams piloted and tested different programs and initiatives to help businesses raise their AI fluency, understand its commercial value, and acquire the skills, frameworks, and talent base necessary to compete and innovate using the technology. We also worked to help businesses develop the proficiency required to execute projects as part of a larger AI strategy.

In 2020-21 our focus was on scaling our industry programs, including our collaborative projects, training for professionals, and recruitment events. Led by top Vector researchers and practitioners, these programs help technical teams build fundamental and advanced skills, while also

delivering key business insights to executives and non-technical professionals.

Vector's Three-Year Strategy enables further progress on these fronts. As businesses and institutions look to AI to adapt, innovate, and compete, we continue to ramp up our strengths and readiness to help them succeed.

2020-21 HIGHLIGHTS

- Vector welcomed Roche Canada as a Gold industry sponsor in 2020, at which time the company announced launched the Roche AI Centre of Excellence (CoE), the first such collaborative centre to combine the expertise of all three national AI institutes under the CIFAR Pan-Canadian AI Strategy: Amii, Mila and the Vector Institute. A global health care leader with a focus on pharmaceuticals and diagnostics, Roche is engaging with Vector to advance and accelerate its goals in emerging health-related AI technologies, talent, and training.
- Vector advanced our work with small-to-medium-sized enterprises (SMEs), including a new professional development program supported by the National Research Council of Canada Industrial Research Assistance Program.
- Since its inception in late 2020, Vector's new AI Engineering team has been supporting our industry sponsors, creating unique software tools and demonstrations for use in collaboration projects and engaging with 17 industry sponsors on their engineering priorities.





VECTOR INSTITUTE INDUSTRY SPONSORS

PLATINUM

Founding

Accenture

BMO Financial Group

Google

Loblaw Companies Ltd.

NVIDIA

RBC

Scotiabank

Shopify Inc.

TD Bank Group

Thomson Reuters

GOLD

Founding

(except where noted)

Air Canada

CIBC

CN

Deloitte

EY

Georgian

Intact Financial Corporation

KPMG

Magna International

Manulife

PwC Canada

Roche Canada*

Sun Life Financial

TELUS

Thales

* As of 2020

SILVER

Founding

EllisDon Corporation

Linamar Corporation

BRONZE

** Denotes Founding
Industry Sponsor*

Ada

BenchSci

Canvass Analytics Inc.

Clearpath*

Darwin AI

Deep Genomics*

Dessa*

FreshBooks*

GoldSpot Discoveries Inc.

integrate.ai*

Layer 6*

League

MindBridge Analytics Inc.

ROSS Intelligence*

Stradigi AI

Surgical Safety Technologies

tealbook

Wattpad*

Wysdom AI

Programs and Courses for Industry

In 2020-21, Vector's programs for upskilling industry focused on application. Our programs centred on real-world challenges over theory, and our courses for technical professionals were structured around capstone projects — use cases that focused on applying AI to scenarios within the participants' companies and connecting skills training and theory to practical application. These are shared with the Vector research community to foster productive connections and knowledge-sharing between industry and academia.

VECTOR INTRODUCES NEW BIAS IN AI PROGRAM

Vector's newest technical education program is tailored to the needs of small-to-medium-sized enterprises (SMEs). Twenty-six professionals from 10 SMEs participated in the inaugural five-week virtual session of *Bias in AI: Practical Examples in Natural Language Processing & Computer Vision*. Funded by the National Research Council of Canada Industrial Research Assistance Program, the session provided these professionals with the technical skills to develop responsible applications of AI where bias may exclude or disadvantage population segments. Participants developed capstone projects based on real scenarios in their own organizations.

CERTIFICATE COURSES

Vector's certificate courses cover AI from first principles to new deep learning models, considering business application at each stage through case studies and capstone projects derived from real company scenarios. They are designed to help industry sponsor personnel master technical knowledge and application of foundational machine learning algorithms. With instruction from Vector's leading research faculty and TAs and combining technically rigorous academic content with real-life business applications, these courses enable participants to gain valuable experience solving real-world problems and create business value with AI. This year's certificate courses featured curricula in machine learning, deep learning, and reinforcement learning.

ENDLESS SUMMER SCHOOL PROGRAM

Vector researchers teach advanced technical skills and techniques in a series of seminars that help practitioners stay up-to-date on the latest technical advances relevant to industry. This year's topics included Combining Tech and Governance for Privacy Protection, Talent Spotlights, and several seminars related to COVID-19 around understanding Dataset Shift and the use of Natural Language Processing (NLP) and 3D Mapping, among others.

BUSINESS INSIGHTS SERIES

Focused on helping participants develop their AI strategies, these sessions provide non-technical professionals with new perspectives and frameworks for understanding AI opportunities, implementation, and scale. Senior leaders examine business opportunities and implications of AI through

guided case studies that introduce AI and delve into AI governance, project management, and the communication practices that support successful adoption. Topics this year included Intro to AI, Putting Data to Work, AI Talent, and Agile AI.

FACE-TO-FACE PROGRAM

The Face-to-Face (F2F) program provides opportunities for industry sponsors to participate in individual meetings with Vector researchers and receive advice and feedback on highly specific AI challenges. 18 such meetings this year involved nearly 40 different industry participants, including a global consulting firm that explored refining models for advanced business tools such as chatbots and automated help lines to better serve their customers and a mobility industry leader seeking AI-driven improvements in infrastructure monitoring and obstacle detection in autonomous transportation.

COMMERCIALIZATION SESSIONS

Commercialization education sessions connect Vector's entrepreneurial researchers to experienced industry specialists, founders, investors, and advisors to build their networks and enhance their understanding of key concepts. These include intellectual property, venture capital, contract law, patent eligibility, and entrepreneurship. This year's sessions featured presentations from Janet Bannister (Real Ventures), Patrick Lor (Panache Ventures), serial entrepreneur and neuroscientist Milad Alucozai, Katrina Albert (Lux), Azar Azad (AI Vali) and leaders from the Ontario Centre of Innovation (OCI), University of Toronto Entrepreneurship (UTE), Next AI, and the Creative Destruction Lab.

COLLABORATIVE PROJECTS

Vector's collaborative projects have proven to be a successful model that enables technical professionals to work alongside Vector researchers and industry peers as they gain hands-on experience with AI models and techniques and apply them to create value within their companies. Project themes are selected based on needs identified by industry and potential for widespread impact.

This year, Vector completed five projects with 95 participants from 15 sponsors. We also launched five new projects with more than 170 participants from 21

NLP REPORT AND SYMPOSIUM

With the aim of helping other organizations build, deploy, and gain value, Vector and industry sponsor participants shared their findings and insights from this collaborative project involving 16 industry sponsors. The project teams published a technical report and participated in a two-day symposium featuring presentations and hands-on workshops by the project participants and Vector researchers. Keynote speakers included He He, Assistant Professor, Computer Science and Data Science, New York University; Khalid Al-Kofahi, former Vice President, Research & Development and Head, Center for AI & Cognitive Computing at Thomson Reuters; and Vector Faculty Members Jimmy Ba, Gennady Pekhimenko, and Frank Rudzicz.

sponsors up to this point. Our new dedicated Project Management Office helps drive success, continued growth and impact in these projects.

This year's projects included:

- Model-Based Reinforcement Learning (MBRL)** – This year, Vector concluded a major MBRL project involving several sponsors. Participants explored MBRL methodologies applied to operational processes to help reduce their carbon footprint in different aspects of their businesses. For example, TELUS and Vector teams collaborated on a model that achieved energy efficiency increases of up to 15 per cent in a data centre cooling simulation. The model was then tested in a real-world setting, where the results were validated.
- Natural Language Processing (NLP)** – Involving participants from 16 industry sponsors, Vector's NLP Project concluded this year with a technical report and two-day symposium. Exploring how advanced NLP techniques can deliver business value, working groups executed experiments relevant to industry needs, replicating and fine-tuning a state-of-the-art NLP model to automate speech and text processing in areas such as health, law, and finance. An additional group developed NLP-based approaches to help the medical community address COVID-19-related questions. Inspired by their successful participation, Vector industry sponsor Manulife founded their own in-house NLP Academy to apply advanced analytics, and hired a Vector researcher to join the Academy to build on the collaborative work to date.

- Understanding Dataset Shift and Potential Remedies** – Industry sponsors gained valuable hands-on experience with techniques for managing major shifts in datasets that can impact the reliability of predictions using past data. This project reflected the reality companies face as business conditions and datasets evolve. Six sponsors across different sectors developed highly relevant skills in understanding and identifying dataset shift problems, and implementing potential solutions.
- Computer Vision** – Vector launched a new project in computer vision in which technical professionals from nine participating sponsor companies are exploring state-of-the-art models in perceptive and generative capacities of visual systems, to apply this learning to specific use-cases in their own organizations.
- Entity Resolution** – Professionals from seven Vector industry sponsors are developing new capabilities in using machine learning to identify and consolidate records in a dataset referring to the same entity (such as proper name variations) across different data sources. The purpose of the project is to explore how machine learning can help reduce the burden on human teams responsible for assessing and resolving records, while also reducing the number of false positives.
- Planning for Two New Collaborative Projects** – Fueled by our shared successes with industry sponsors, Vector's industry innovation team is developing new collaborative projects for 2021-22, including: Accelerate AI, in which participating industry sponsors will co-create

a framework of best practices and strategies aimed at improving internal cross-functional and inter-organizational collaboration on AI deployment projects; and Trustworthy AI, in which participating sponsors will identify best practices and develop use cases for the responsible implementation of AI models.



SNAPSHOT: Ontario's Vibrant AI Ecosystem 2020-21 Metrics



As part of our ongoing leadership in reporting on the health of the Ontario AI ecosystem, Vector publishes an annual Ontario AI Snapshot in collaboration with Deloitte Canada.

Based on market research that includes a survey of executives and readily available data, the report tracks 10 metrics in job creation and retention, investment, application, commercialization, and more. They serve as benchmarks for measuring the collective progress of governments, businesses, and institutions in further strengthening Ontario's AI ecosystem.

The inaugural Snapshot was presented at Deloitte's AI institute launch by Vector's Chief Commercialization Officer and Vice President, Industry Innovation Cameron Schuler in early 2021.

Here are the metrics captured in the second annual snapshot, which covers April 1, 2020 to March 31, 2021:

INDICATORS OF TALENT & JOB MARKET

1. More than **1,400** students began their studies in AI-related master's programs, with 950 students enrolled in Vector-recognized AI master's programs and a further 450 students in individual AI-related study paths. More than **700** AI master's students graduated in Ontario this year. Meanwhile, Vector's research community grew to **617**, including 136 Faculty, 45 Postdoctoral Fellows, 245 PhDs, 101 master's students and 90 undergraduate students.
2. An estimated **7,253** AI jobs were created, and **13,758** AI jobs were retained in Ontario.

3. Ontario created an estimated **2,922** well-paying jobs held by highly qualified professionals (HQPs) graduated from AI-related programs.



INVESTMENTS IN EDUCATION & BUSINESS

4. **41** new AI-related patents were filed by Canadian inventors.
5. An estimated **\$612 million** to **\$4.5 billion** was spent on AI research and development in Ontario (i.e., budgeted R&D expenditures and allocation of external funding). This represents an increase by a factor of between 5.5 and 6.3x, compared to the previous year.
6. **13** companies moved into the Ontario AI ecosystem and **212** companies invested in it.
7. **\$2.16 billion** in venture capital investments flowed into Ontario's AI ecosystem.

MARKET SIZE & AI ADOPTION

8. **35** new AI companies were established in Ontario.
9. More than half (**51** per cent) of business executives consider AI to play a strategically important role in achieving their company's business objectives or that a formal AI strategy was implemented within all business units.
10. More than half (**57** per cent) of Ontario companies have commercialized AI products or services or use AI to sell their core products or services.

The complete Ontario AI snapshot for 2020-21 will be available soon on the Vector Institute website at vectorinstitute.ai [↗]



TALENT AND WORKFORCE DEVELOPMENT

1,400

AI master's students began their studies this year (950 in Vector-recognized programs and 450 in individual AI-related study paths)

722

Total number of master's students who graduated this year

1,282

AI-related job postings by 57 Ontario employers on Vector's Digital Talent Hub

106

Students offered scholarships, representing 31 programs at 12 Ontario universities

22

Vector-recognized AI programs in Ontario

40

Companies that participated in career events to meet and recruit students

1,169

Candidate profiles on Vector's Digital Talent Hub

1,674

Total attendance by students in career events

Talent and Workforce Development

Vector continues to grow Ontario’s pool of workforce-ready AI talent, and to connect that talent to Ontario employers. Our efforts span the journey from recruiting top talent to study in Ontario to helping them develop job-search skills to supporting students as they enter the workforce. Initiatives include: helping Ontario universities enhance AI-related curricula and develop new AI master’s programs that will attract promising next-generation talent; awarding vital scholarships supported by the Province of Ontario to attract the brightest students to study and train here; and supporting students in their transition to the workforce through work-integrated learning opportunities, job search skill development, and robust connections to employers.

This year, we continued to scale up our efforts on talent and workforce development. These efforts are paying off:

- More than 700 graduates from Vector-recognized master’s programs and AI-related study paths in 2020-21.
- Continued growth in the number of competitive candidates from Ontario, Canada, and the world enrolling in these programs and study paths (1,400 in 2020-21), with a record number meeting the criteria for and receiving the highly competitive Vector Scholarship in Artificial Intelligence.
- Promising employment impact in Ontario: Nearly **85 per cent** of graduates¹ from Vector-recognized AI programs are employed within 12 months of graduation in spite of the COVID-19 pandemic; **93 per cent** of those employed have remained in Ontario working in a broad range of sectors.

AHEAD OF SCHEDULE

Based on current enrollment projections, more than 1,000 students are expected to graduate from AI master’s programs in Ontario in 2021-22, which means Vector is on track to exceed the target set by the Province of Ontario to graduate 1,000 AI master’s students per year by 2023.

EMPLOYMENT BY SECTOR FOR GRADUATES OF VECTOR-RECOGNIZED AI MASTER’S PROGRAMS IN ONTARIO¹

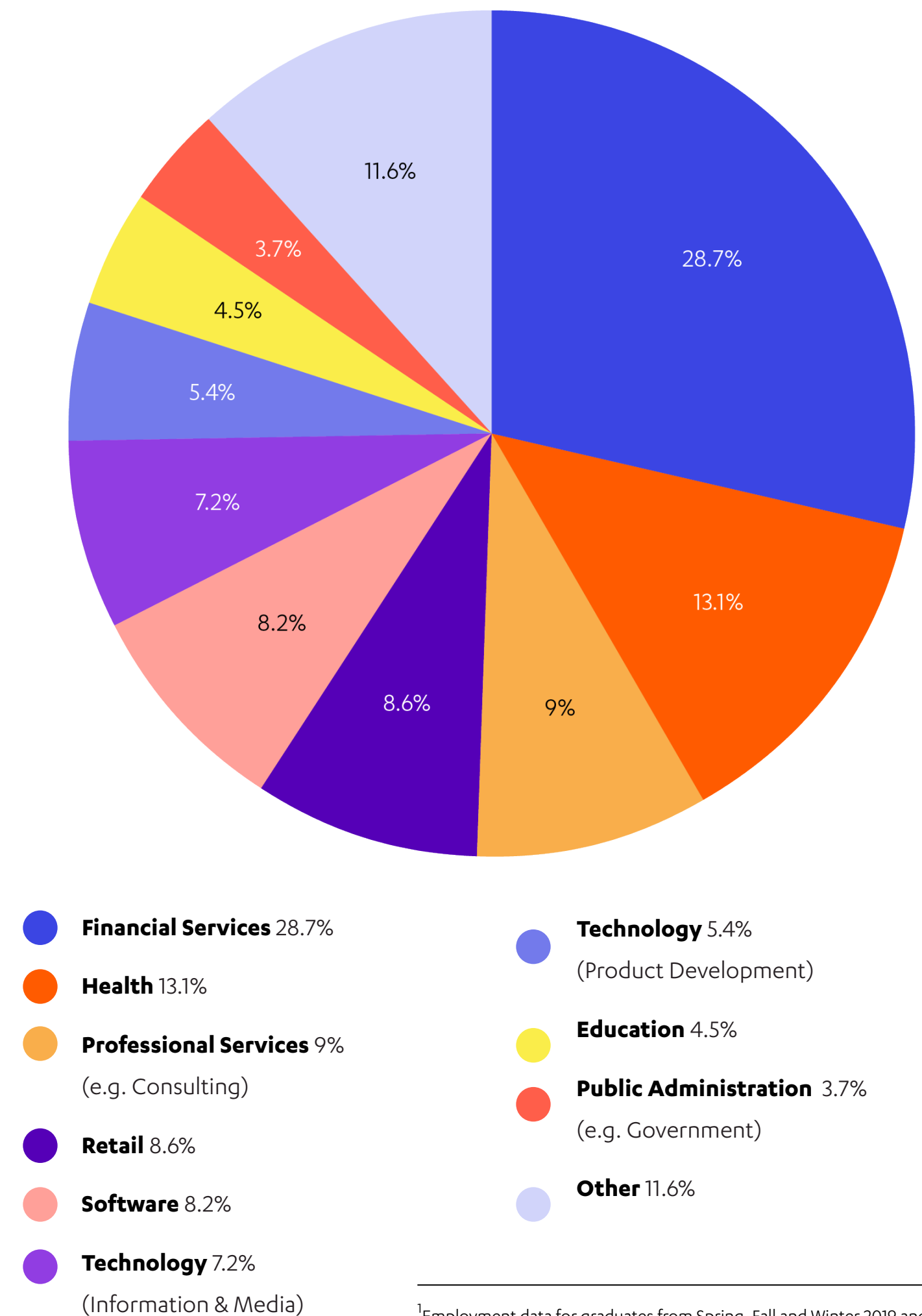

¹Employment data for graduates from Spring, Fall and Winter 2019 and Spring and Winter 2020, within 12 months of graduation.

Spotlight on Rising Talent



Mohak Poddar graduated in 2020 from the University of Toronto's Master of Management Analytics program (a Vector-recognized master's program). He earned his BAsC in Computer Engineering at the University of Toronto in 2016.

Mohak completed internships at UHN, Allied Digital Services, and York Region prior to securing his internship at Shopify (a Vector industry sponsor) in 2020 through the Digital Talent Hub. In September 2020, Mohak was hired at Shopify full-time as a data scientist.

"My role at Shopify has helped me grow into the professional I am today. I've gained lots of technical skills, but even more importantly, I've gained a host of new essential soft skills: knowing where to best invest my time, working with others across departments, and determining the benefits and risks of new projects. If it wasn't for the Talent Hub, I would never have known about the internship opportunity at Shopify that led to my full-time role."

— **Mohak Poddar, Data Scientist, Shopify Inc.**



2020-21 VSAI recipient **Sara El-Shawa** is pursuing her MASc in Computer Engineering (AI Specialization) at the University of Guelph, where she has joined the Machine Learning Research Group led by Vector Faculty Member and Canada CIFAR AI Chair Graham Taylor. Inspired by her earlier studies in computer science and biology, Sara is interested in how AI can be applied within genomics and health care. In addition to interning at Vector, Sara is collaborating with the Center for Biodiversity Genomics on a project that is advancing the accuracy and efficiency of DNA barcoding to more accurately assess global biodiversity and its change over time. Sara is also working with researchers at the University of Toronto and Harvard University on a machine learning project that seeks to better understand human social networks in a post-pandemic world.

"Vector has played a key role in my exposure to the field of AI. As a VSAI recipient and a Vector intern, I've been able to explore different areas of research, work on a wide variety of AI projects, and attend events that exposed me to new ideas outside my own field."

— **Sara El-Shawa, Vector intern**

Helping Ontario Employers Attract and Retain Top AI Talent

As the world embraces the potential of AI, the global competition for top academic and workplace talent is intensifying and employers around the world are searching for talent in Ontario's AI ecosystem. We continue to innovate to develop a robust pipeline of outstanding career-ready AI talent, helping Ontario employers connect to the next-generation workforce that will help them stay competitive.

Recognizing that the AI talent market is a unique environment, we have invested considerable effort in developing data and AI-specific career and recruitment support. We help graduates understand the job market and broader landscape, hone the skills they need to be competitive, refine their job-search skills, and build pathways in different sectors.

This year, we increased our talent search and recruitment-related events and online support to connect talent to work opportunities and ease the pandemic's impact on new graduate hiring activity.

Highlights include:

- Hosting 12 events, up from four in 2019-20; student attendance grew by 103 per cent over the previous year.
- Adding new programming to help students and recent graduates improve their job-search skills, including a series of webinars and personalized

coaching sessions tailored to the AI market through our new collaboration with talent development leader Phase AI.

- Attracting greater participation by our industry sponsors in our recruitment events, up 50 per cent over the last year.

77%

growth in the number of employers on the Digital Talent Hub

*62 up from 35 in the previous year.

266%

increase in the number of job seeker profiles on the Digital Talent Hub

*1,169 up from 439 in the previous year.

DIGITAL TALENT HUB

A proven platform for vetted, workforce-ready AI candidates, our Digital Talent Hub connects Vector's community of students, researchers and alumni with internships and full-time public and private sector opportunities.

WORK-INTEGRATED LEARNING

Vector bridges the gap between theoretical and applied AI, helping emerging talent build the real-world skills companies seek by connecting them with

internship opportunities in a range of sectors. This year, 169 internships were available, up from 46 in the previous year, driven in part by rapid growth in the number of postings by employers on Vector's Digital Talent Hub as well as new opportunities generated through our partnership with Mitacs, a national, not-for-profit research and training organization with which Vector collaborates to rapidly connect machine learning students to employers. These work-integrated learning opportunities at organizations such as A.I VALI, Cyclica, Xanadu, Linamar, and Thales help top students prepare for meaningful career paths in Ontario with SMEs as well as larger enterprises.

AI MASTER'S SUMMIT AND CAREER FAIR

This year, Vector hosted its second annual AI Master's Summit and Career Fair, where nearly 400 AI master's students from 15 universities heard from industry leaders in AI and learned about career opportunities with industry sponsors.

The event kicked off with a plenary session, followed by concurrent sessions which included lightning round pitches by Vector's Platinum sponsors, a career fair featuring 26 employers, research talks, and a virtual networking room with alumni. In addition to Vector Faculty Members, Faculty Affiliates, and Vector industry sponsors, participants included special guests Donna Skelly, Parliamentary Assistant for Job Creation and Trade to the Minister of Economic Development, Job Creation and Trade, Dr. Foteini Agrafioti, Head, Borealis AI & Chief Science Officer at RBC, and Dr. Ella Hilal, Head of Data Science and Engineering, Revenue and Growth at Shopify.

Vector Scholarship in AI (VSAI)

Supported with funding from the Province of Ontario, VSAs are merit-based scholarships which recognize top candidates pursuing studies in either Vector-recognized AI master's programs or individual AI study paths in Ontario, including programs in core technical and complementary areas such as business and health. These scholarships assist universities in attracting high calibre students to Ontario programs where they develop the AI skills and competencies sought by employers.

Graduates of AI master's programs will meet increasing demand from leading global companies as well as promising AI startups and scaleups, helping to grow Ontario's AI workforce.

In 2020-21, VSAs were offered to 106 of the best and brightest incoming master's students representing 31 programs across 12 Ontario universities. The growth in applications from candidates in Ontario, Canada, and around the world (up 50 per cent over last year) and number of programs nominating students — including 14 programs that nominated students for the first time this year — speaks to the growing presence of leading AI content in Ontario curricula, as well as the province's increasing appeal as a destination for outstanding Canadian and international talent.

AI Master's Programs and Related Study Paths at Ontario Universities

Vector's committee of industry representatives and faculty recognizes 22 AI master's programs at 11 universities across Ontario that graduate students with the skills and competencies highly sought by industry. Of these 22 recognized programs, four are new degree programs, while 12 are programs whose curricula have been updated to offer AI-specific minors, concentrations, and courses. These programs contribute to an increase in workforce-ready AI candidates who, in turn, participate in Vector-led programs for connecting graduates and alumni into the Ontario economy.

One asterisk * - 2020-21 scholarship recipients

Two asterisks ** - Vector-recognized master's programs

Carleton University

*MSc in Electrical and Computer Engineering

University of Guelph

**Collaborative Specialization in AI (MSc in Engineering, MSc in Computer Science, MSc in Mathematics, MSc in Bioinformatics)

Lakehead University

**MSc in Computer Science (AI Specialization)

McMaster University

*MSc in Computer Science

Ontario Tech University

**Master of Information Technology Security (Artificial Intelligence Security)

University of Ottawa

**MSc/M.Eng in Electrical and Computer Engineering (Applied AI)

**MSc in Computer Science (Applied AI)

Queen's University

*MSc in Applied Physics

**MSc in Electrical and Computer Engineering (Field of Study in AI)

*MSc in Mathematics and Engineering

**Master of Management Analytics; Global Master of Management Analytics

**Master of Management in Artificial Intelligence

**MSc in Computer Science (Field of Study in AI)

Ryerson University

**M.Eng in Electrical, Computer, and Biomedical Engineering (Field of AI)

**MSc in Data Science and Analytics

University of Toronto

*MSc in Aerospace Studies

*MSc in Electrical and Computer Engineering

*MSc in Mechanical and Industrial Engineering

**Master of Management Analytics

**Master of Health Informatics

*MSc in Applied Computing

*MSc in Computer Science

**MSc in Health Policy, Management, and Evaluation (Emphasis in Health Systems AI)

University of Waterloo

*MSc in Electrical and Computer Engineering

*MSc in Systems Design Engineering

**Master of Data Science and Artificial Intelligence

**M.Math in Data Science

*M.Math in Computer Science

Western University

**Collaborative Specialization in Artificial Intelligence (MSc in Computer Science, MSc in Electrical and Computer Engineering)

**Master of Data Analytics (AI Specialization)

University of Windsor

**MSc in Computer Science (AI Concentration)

York University

**Master of Business Analytics (MBAN)

**Master of Management in Artificial Intelligence (MMAI)

**MSc in Computer Science (AI Specialization)

Spotlight on Vector Alumni

Vector alumni are active members of our community, participating in Vector-hosted events and initiatives, building on research and reinforcing productive relationships with our industry sponsors and the broader AI ecosystem.



GA WU

*Vector Postgraduate Affiliate (2017-2020)
Member, 2021-22 Vector Scholarships in AI
Adjudication Committee*

Current Role: Machine Learning Researcher,
Borealis AI

How did your time at Vector impact your career?

The opportunity to interact and collaborate with different people at Vector helped shape the way I approach and think about problems. This has had a long-term positive influence on my career.

Ga Wu also found his current role at Borealis AI via Vector's Digital Talent Hub.

How is your research making a difference?

We note that 90 per cent of machine learning models are not being deployed in real products. The reason usually involves model safety considerations, such as robustness, fairness, and long-term reliability. My work on model safety research aims to tackle this problem.



MELISSA MCCRADDEN

Vector Postdoctoral Fellow (2019)

Current Role: Bioethicist, The Hospital for Sick Children; Assistant Professor, Dalla Lana School of Public Health, University of Toronto (status only)

How did your time at Vector impact your career?

Having an embedded experience within computer science better prepared me to tackle the ethical challenges relating to the use of health care AI. As a medical ethicist (bioethicist), I don't need to understand everything about medicine, but I do need to know enough to understand the benefits, risks, and possible consequences. It's the same with AI, and staying up-to-date with the technology is so valuable. Also, the connections I've made at Vector are the same folks I continue to work with now.

How is your research making a difference?

Our research project on explainability in point-of-care ML tools is being used to guide decisions about the research and translation of tools at SickKids. My work in bias is currently used as part of our evaluative process with the research ethics board. Our templates provide guidance and suggestions to researchers to help them query and quantify bias in their research.

HEALTH

Vector's health strategy is a key pillar of our founding mission and Three-Year Strategy, recognizing that the diverse, population-wide data in Ontario's large, single-payer health system represent a significant opportunity to apply AI to improve health research, systems, and care. We engage with partners in the health and academic sectors to advance our goal of enabling effective and appropriate research access to health data towards better whole life health.

Anchoring these efforts is Vector's Smart Health Initiative, which aims to leverage our AI and machine learning research to help hospitals reduce costs, provide patient-centred care, and improve clinical outcomes. Supported in part by a new funding commitment from the Province in 2020-21, the multi-year Smart Health Initiative focuses on:

Data Governance – Vector continues to lead in the development of modern data governance frameworks to increase access to data for researchers with a focus on security, privacy, and confidentiality.

Partnerships – Vector is active in facilitating improved access to health data through partnerships and initiatives with leading organizations in Ontario's health system.

Research & Scaling Deployment – Vector enables world-leading AI research across health disciplines and supports practical deployment of AI models and applications in a range of health care environments.

Talent & Training – Vector develops programs tailored to clinicians and other professionals in the health sector to connect them to career paths, support recruitment, and develop new skills in deploying AI in health, including through Vector's Digital Talent Hub.



VECTOR CONTRIBUTES CUTTING-EDGE COMPUTE RESOURCES AND EXPERTISE TO THE ONTARIO HEALTH DATA PLATFORM (OHDP)

In Spring 2020, Vector announced our contribution of scientific computing equipment to enable the Province to establish high-performance computing facilities for its new Ontario Health Data Platform (OHDP). Linking health datasets from a variety of sources to create an unprecedented volume of rich, connected data, OHDP offers researchers the potential to anticipate epidemiological trends, generate new clinical insights, and develop treatment innovations to support COVID-19 responses.

In addition to providing essential AI computing infrastructure, Vector also provides AI-specific expertise on privacy and ethics for the OHDP. Vector researchers now use the platform to lead vital COVID-19 research on topics such as disease outcomes, hospitalization rates, social inequities, and the allocation of resources such as tests, ventilators, and staffing.

While OHDP was initiated due to COVID-19, it will also be used for longer-term purposes. Vector continues to work closely with the Ministry of Health to provide insights as the initiative evolves and new phases are implemented.

DATA GOVERNANCE

Vector advanced new perspectives on best practices, policies, and unique considerations for governing use of AI in health contexts, working with legal experts towards finalizing such data governance frameworks as data sharing agreements, data use agreements, and governance agreements that can be adapted for use by Ontario research and health institutions.

PARTNERSHIPS

Vector established and expanded agreements with hospitals, clinical research institutes, and related health sector partners to enable safe, secure access to health data. These data will help Vector researchers advance important work across a range of subject areas, including cancer imaging, pregnancy, and measuring stress and recovery in frontline COVID-19 health care workers.

This year also marked the beginning of a new collaboration between Vector and The Michener Institute of Education at UHN, with support from the Future Skills Centre. The initiative aims to transform the knowledge, skills, and capabilities of front-line health care professionals to apply AI in health care settings to improve patient care and outcomes

PATHFINDERS

In 2018, Vector identified and supported a suite of early-stage AI projects led by hospitals and institutions across Ontario, selecting projects with strong potential to be effectively scaled and deployed. These trailblazing projects have begun to scale and are generating practical insights to ease the path to deploying other AI activities in clinical settings. Vector shares insights and best practices from these projects

with health practitioners to fuel AI knowledge and tools that can improve health care outcomes and efficiencies.

- **CHARTwatch: Reducing Risk Through Prediction**

Working with Unity Health Toronto, Vector supported the development of an AI-powered automated early warning system that predicts when a patient may need to be transferred to intensive care, enabling earlier intervention to improve health outcomes. Now deployed at Unity Health's St. Michael's Hospital, preliminary results have indicated a 20 per cent reduction in mortality among 3,000 high risk patients.

- **CORAL Review: Enabling Better Radiology Diagnoses**

Using algorithms developed by Vector Faculty Members, this AI-enabled peer review software is able to compare patient chest imaging results to thousands of existing medical images, to help recommend or validate a diagnosis made by the physician. Current testing and validation shows an 80 per cent accuracy of this search model.

- **MEDLY: Improving Cardiac Patient Care**

In collaboration with Vector Faculty, UHN has developed a machine-learning-based app that remotely monitors vital signs and symptoms of Congestive Heart Failure (CHF) patients in real time, helping them manage their care at home, improving care and reducing unnecessary hospital admissions. The app is currently being tested by more than 300 patients with heart disease.

- **Tick Identification: Improving Risk Assessment**

Vector researchers and technical staff are working with Public Health Ontario to develop a mobile app that uses computer vision to quickly identify tick species. The goal is to reduce the risk of Lyme disease by supporting more timely medical interventions when necessary. A 'minimum viable product' of the app is currently undergoing user acceptance testing for both online and offline use.

VECTOR RESEARCHERS RISE TO THE CHALLENGE OF COVID-19

In addition to Vector's contribution of powerful computing resources and expertise to the development of the Ontario Health Data Platform (OHDP), Vector researchers responded to the COVID-19 pandemic with new projects and engagements. These include projects on the OHDP that were intended to guide policymakers' pandemic responses, on such topics as disease outcomes, hospitalization rates, and social inequities.

Simultaneously, the Vector research community responded quickly to undertake a wide range of internationally important research. Five Vector-led projects were among those awarded CIFAR's AI and COVID-19 Catalyst grants and involved Alán Aspuru-Guzik, Marzyeh Ghassemi, Anna Goldenberg, Quaid Morris, and Jimmy Lin. Additional highlights include: Bo Wang's research on phenotyping of the virus; Hamid Tizoosh and Alex Wong's work on CT images of COVID-19 from China to identify the severity of the disease for treatment planning; and Laura Rosella's involvement in #Howsmyleftening, a centralized data analytics and visualization hub monitoring Ontario's response to COVID-19.

GENERAL MEDICINE INPATIENT INITIATIVE (GEMINI)

The GEMINI project started as a project at Unity Health St. Michael's Hospital in Toronto to test and refine an AI-based early warning system for the hospital's general internal medicine (GIM) unit. The project is now scaling to involve data from 30 hospitals - one of the largest sets of hospital inpatient data in Canada - and has expanded beyond its original scope to enable participating organizations and researchers to develop machine learning models for an array of data projects including those related to Ontario's COVID-19 pandemic response. Vector recruited three full-time technical employees to support the project's data infrastructure growth.

HEALTH AI DATA ANALYSIS PLATFORM (HAIDAP)

As one of our first projects to enable AI health research in a secure compute environment, this high-performance infrastructure, built in a collaboration between Vector, ICES, SickKids/UHN (HPC4Health), and Compute Ontario, makes de-identified population-wide health data available for AI, machine learning, and other computation-intensive advanced analyses. There are currently 48 active or completed health AI projects from universities across Ontario which have been running on HAIDAP equipment, 28 of which have a Vector Faculty Member or Faculty Affiliate listed as an investigator. HAIDAP infrastructure has also supported other groups in the HPC4Health environment, including GEMINI, UHN, and SickKids.

TALENT, TRAINING, AND KNOWLEDGE MOBILIZATION

Vector develops education and training programs that upskill Ontario's health workforce to enhance AI deployment in health practices and systems. Our teams also participate in events aimed at sharing knowledge and practices with a broader community of researchers, practitioners and policymakers. Highlights of 2020-21 education programs and events include:

- AI Enabled Care: Building Collaboration for Deeper Learning and Better Care** — Vector co-led this inaugural symposium on critical topics in health AI implementation in clinical settings, in collaboration with The Michener Institute of Education and IVADO. More than 300 Canadian and international health care leaders, researchers, and policy makers attended, paving the way for future national and international dialogue on health AI.
- Health AI Research Ethics Education** — Vector partnered with the Canadian Association of Research Ethics Boards (CAREB-ACCER) for an inter-disciplinary panel event entitled Research Ethics Considerations for AI Research in Health. Over 340 stakeholders discussed ethical considerations for novel AI applications in health, including how algorithmic tools are being designed and used in health research and AI-related issues such as privacy and bias. Subsequent educational webinars engaged the CAREB-ACCER community in training on data privacy and security, and addressing bias.
- Association for Computing Machinery Conference on Health, Inference, and Learning (ACM-CHIL)** — Vector Faculty Members and research community members were once again instrumental in organizing this international conference that brought together world-class industry and academic machine learning researchers, clinicians, and health policymakers to discuss topics in health AI such as causality and fairness.
- CIFAR AI + Society Program: Regulation of Medical Devices with AI** — At this CIFAR-hosted workshop, participants considered safety and privacy laws that could apply to AI-based health technologies. Vector researchers and professional staff shared key perspectives on the intersection of AI innovation and regulation, and on the redistribution of legal risks associated with AI medical devices.

TECHNOLOGY & AI ENGINEERING

In 2020-21, Vector established a new AI Engineering team, which has the mandate to translate Vector's leading AI research into new and responsible AI applications for industry and health, and to provide leading-edge engineering support to accelerate research.

In September 2020, Vector hired Ron Bodkin as the inaugural VP AI Engineering & Chief Information Officer, with a cross-appointment as Engineering Lead at the Schwartz Reisman Institute for Technology and Society. A serial entrepreneur, Ron joined Vector from his previous role as a leader for Applied Artificial Intelligence in Google's Cloud CTO office.

FIVE KEY PRIORITIES GUIDE THE GROWING TECHNOLOGY TEAM

- **Industry** — Our objective is to support Vector's industry sponsors through knowledge transfer programs and provide these companies with the know-how and hands-on experience to adapt and operationalize reference applications, tools, frameworks, and model templates within their organizations.
- **Responsible AI** — Collaborating with the Schwartz Reisman Institute for Technology and Society, we aim to develop technology and frameworks for operationalizing responsible

AI that can help industry and health partners address common technical challenges related to AI governance, fairness, explainability, value alignment, interpretability, privacy, and security and that can help inform public policy for AI.

- **Health** — We support the application and operationalization of innovative AI tools and solutions in Canadian health organizations with a focus on privacy, technology modernization, and collaboration with practitioners.
- **Research** — We are investing in accelerating our researchers' ability to conduct and reproduce experiments and push forward the frontier of AI research by enhancing our AI infrastructure, fostering the most promising innovations, and seeking to demonstrate their implications for AI practice, including through open-source publication and maintenance.
- **AI Infrastructure** — We operate one of the world's most significant non-profit machine learning computational infrastructures, including thousands of GPUs, petaflops of computation, large-scale data management, modern training frameworks, experiment workflow tools, and prioritized fairshare scheduling.

EARLY IMPACT WITH INDUSTRY SPONSORS

Since its inception in fall 2020, the AI Engineering team is already having valuable impact, providing guidance, expertise and tailored software tools to support Vector's industry sponsors and their collaborative projects with Vector, and supporting Vector researchers with software engineering challenges.

HIGH PERFORMANCE COMPUTING

By Fall 2020, Vector had installed an additional 240 Nvidia RTX6000 Graphics Processing Units (GPUs) and corresponding scientific computing servers, making them available to the Vector community for research purposes.

This year, we piloted a new initiative to increase access to our scientific computing infrastructure Vector Faculty Affiliates and additional Postdoctoral Fellows and graduate researchers working with Faculty Affiliates. Following the initial pilot, we are now formally expanding access to these high performance compute resources to this growing research community.

RESEARCH AND BUSINESS COMPUTING AMIDST COVID-19

Amidst the COVID-19 pandemic and related stay-at-home conditions, the team supported a seamless pivot to remote computing for Vector's research and business activities. This includes uninterrupted access to high-performance computing resources for researchers, and an organization-wide deployment of tools and platforms to support remote work.

THOUGHT LEADERSHIP: BRIDGING AI WITH SOCIETAL AND ECONOMIC IMPACT

Vector's community includes industry and scientific leaders, noted economists and entrepreneurs, prominent health stakeholders, and others who have unique and informed perspectives on important AI issues.

Our researchers and partners work to realize AI's promise for industry and society, but also acknowledge legitimate concerns relating to job displacement, fairness, explainability, safety, misinformation, regulations and standards, ethics, and privacy.

We curate and convene these expert perspectives and insights, contributing thought leadership that shapes and informs local, national, and global conversations regarding research, responsible AI, workforce development, economic competitiveness and productivity, and other important topics at the intersection of AI and society.

Our new AI Engineering team has a mandate to advance responsible AI. The team leads Vector's breadth of work ranging from addressing fairness in AI systems, safety, and robustness, to interpretability and ways to improve the transparency and effectiveness of AI systems that affect us all.

Vector also provides guidance to the Ontario university community on embedding responsible AI concepts into their programs and curricula. All Vector-recognized AI master's programs have mandatory curriculum and learning outcomes related to the ethics and societal implications of AI.

Vector continues to convene and participate in interdisciplinary discussions and initiatives related to AI research, as well as the important societal and economic considerations AI research generates.

Our ongoing goal is to bring together the broader community to actively share and contribute expertise and insights on policy issues related to AI adoption that supports the best interests of Ontarians and Canadians.

THE VECTOR-SCHWARTZ REISMAN INSTITUTE FOR TECHNOLOGY AND SOCIETY (SRI) CONNECTION

Ron Bodkin, Vector's new VP AI Engineering, is cross-appointed to the Schwartz Reisman Institute for Technology and Society as Engineering Lead, underscoring the important relationship between the two institutes. Addressing governance, policy, and technology, the collaboration enables Vector to expand research, pilot applications, and scale knowledge and tools within responsible frameworks. Additional cross-appointments between Vector and the Schwartz Reisman Institute include:

- Vector Faculty Members Sheila McIlraith and Toniann Pitassi
- Vector Faculty Affiliates Gillian Hadfield (Director and Schwartz Reisman Chair in Technology and Society) and David Lie

2020-21 HIGHLIGHTS

- Vector Research Director Richard Zemel co-chaired the 2021 ACM Conference on Fairness, Accountability, and Transparency (ACM FAccT). The cross-disciplinary event, fast becoming the leading conference in this important area, brought together leading researchers and practitioners concerned about fairness, accountability, and transparency in socio-technical systems.
- Launched in June 2020, the Global Partnership on AI (GPAI), conceived by Canada and France during their G7 presidencies, is an international initiative with 19 members to promote responsible AI, with its secretariat hosted at the OECD. Garth Gibson, Vector's President & CEO, and Ron Bodkin, Vector's VP AI Engineering & CIO, participated in the December 2020 GPAI Summit. Hosted virtually from Montreal by the International Centre of Expertise in Montreal for the Advancement of Artificial Intelligence (ICEMAI), the summit brought together experts from industry, government, civil society, and academia to advance cutting-edge research and pilot projects on AI priorities, including data governance, innovation and commercialization, future of work, responsible AI, and AI and the pandemic.
- Countries with AI strategies are awakening to the importance of addressing AI's rising compute demands. To help them do so, the OECD recently created the OECD Network of Experts on Artificial Intelligence (ONE AI) task force charged with providing benchmarks for AI compute capacity to national governments, and invited Vector's President & CEO to join and contribute.
- At the third annual AICan event in January 2021, Vector's President & CEO participated in a panel discussion with fellow executives from our peer national AI institutes Amii and Mila, moderated by CIFAR. The event, attended by the federal Minister of Innovation, Science and Economic Development (ISED), also featured research presentations by Canada CIFAR AI Chairs from Vector and our peer AI institutes.

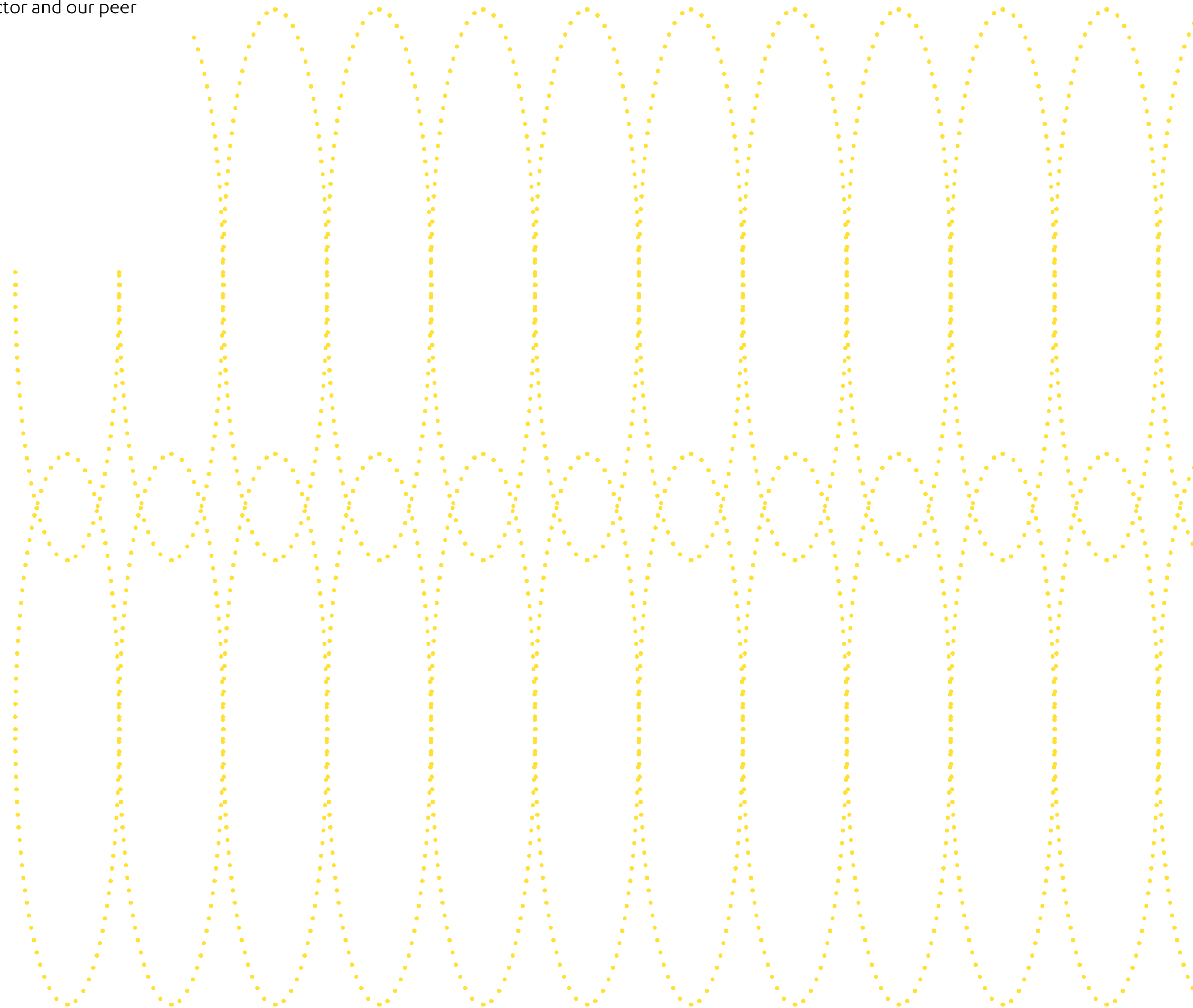

OPERATIONS

While access to the Vector office in the MaRS Centre was limited due to the COVID-19 pandemic, our research and business activities continued virtually without interruption or impact on productivity.

The pandemic also temporarily suspended construction on Vector's future home at the Schwartz Reisman Innovation Centre (SRIC). Work has since resumed, and the facility — designed to promote collaboration among researchers across institutions, and to enable machine learning research powered by high-performance computing equipment — is expected to be ready for occupancy in early 2023.

AFFILIATED INSTITUTIONS

Vector, including its Faculty Members, Faculty Affiliates, Postgraduate Affiliates, graduate researchers, and Postdoctoral Fellows, represents and collaborates with a wide range of institutions across Canada. These include:

Carleton University

Dalhousie University

Hospital for Sick Children (SickKids)

Lakehead University

McMaster University

Ontario Institute for Cancer Research

Perimeter Institute for Theoretical Physics

Queen's University

Ryerson University

Sinai Health System

Sunnybrook Hospital

Toronto Rehabilitation Institute

University Health Network

University of British Columbia

University of Guelph

University of Ontario Institute of Technology

University of Ottawa

University of Toronto

University of Waterloo

University of Windsor

Western University

York University

FINANCIALS

Vector is funded through multi-year commitments from different funding sources, including:

- Provincial funding through Ontario's Ministry of Economic Development, Job Creation and Trade (MEDJCT) to establish the institute, deliver core programming, and support the development of the AI ecosystem.
- Funding from MEDJCT for initiatives related to workforce development, including scholarships and support to develop AI master's programs.
- Funding from Ontario's Ministry of Colleges and Universities for Vector's Smart Health Initiative.
- Federal funding through the Pan-Canadian AI Strategy administered by CIFAR to support the Canada CIFAR AI Chairs Program, graduate training, institute operations, and the participation of the Chairs and trainees in national AI activities.
- Industry sponsorships at various levels and commitments that support Industry Innovation programs and related initiatives.

To date, Vector has operated with a financial support model in which government funding was front-end loaded. This means that cash reserves are used in subsequent fiscal years to support normal business expenses in compliance with transfer payment agreements and the objectives described in Vector's Three-Year Strategy.

This year, Vector's revenue sources included new AI programs, including the NRC IRAP-supported Bias in AI program, and customized workforce and executive training.

Vector Institute's [audited financial statements](#) for the 2020-21 fiscal year are available on our website.

STATEMENT OF FINANCIAL POSITION

March 31	2021	2020
Assets		
Current		
Cash and cash equivalents	\$52,926,452	\$29,080,279
Short-term investments	-	28,000,614
Accounts receivable	6,512,151	2,328,888
Current portion of employee loans	313,377	279,306
HST rebate receivable	-	48,681
Prepaid expenses	558,440	283,011
	\$60,310,440	\$60,020,779
Employee loans	1,267,429	1,426,573
Capital assets	5,512,552	6,169,573
	\$67,090,401	\$67,616,925
Liabilities and Net Assets		
Current		
Accounts payable and accrued liabilities	\$3,623,393	\$ 3,596,301
HST Payable	81,101	-
Deferred rent	593,086	941,542
Deferred contributions	15,752,017	28,667,883
Deferred capital contributions	4,996,907	5,310,165
	\$25,046,504	\$38,515,891
Net Assets		
Unrestricted net assets	42,043,897	29,101,034
	\$67,090,401	\$67,616,925

FINANCIALS

Vector Institute's [audited financial statements](#)[†] for the 2020-21 fiscal year are available on our website.

STATEMENT OF OPERATIONS

March 31	2021	2020
Revenue		
Government grants		
Province of Ontario	\$10,295,672	\$10,276,610
Federal Government	6,837,982	5,535,881
Industry partners	11,136,667	8,708,307
Amortization of deferred capital contributions	4,270,645	1,747,992
Investment income	425,068	802,573
Fees for service	142,871	287,759
Disposal of capital assets	642,315	-
	\$33,751,220	\$27,359,122
Expenses		
Research and education	7,517,472	6,577,168
Industry skills training	88,545	666,075
Technology adoption	3,468,506	3,399,754
Business acceleration	1,400,983	440,764
General and administration	2,822,737	3,635,128
RAISE AI	2,163,193	1,797,007
Employee loans accretion expense (recovery)	30,073	(82,300)
Amortization	3,316,848	2,080,877
	\$20,808,357	\$18,514,473
Excess of revenue over expenses for the year	\$12,942,863	\$8,844,649

TEAM AND LEADERSHIP



MEMBERS AND BOARD OF DIRECTORS

Vector is governed by a highly accomplished volunteer Board of Directors, drawn from the private sector, public sector, academic, and research communities.

Vector's Members of the Corporation and Board of Directors include:

ED CLARK, CHAIR

JANET BANNISTER

CHARMAINE DEAN

JANET L. ECKER

VIVEK GOEL

CHAVIVA HOSEK

NADIR MOHAMED

MICHAEL SERBINIS

TERRENCE SULLIVAN

MELANIE WOODIN

LEADERSHIP

GARTH GIBSON, President and Chief Executive Officer

RON BODKIN, Vice President, AI Engineering and Chief Information Officer

GARY BURLAKOFF, Director, Finance

CAMERON SCHULER, Vice President, Industry Innovation and Chief Commercialization Officer

ROXANA SULTAN, Vice President, Health

ALAN VEERMAN, Chief Operations Officer

RICHARD ZEMEL, Research Director

PROFESSIONAL TEAM

From industry innovation and commercialization to research programs, academic partnerships, health strategy, and more, Vector has an experienced professional team supporting and executing on our mission.



CIFAR **Canada** **Ontario** 

The Vector Institute is an independent, not-for-profit corporation dedicated to advancing artificial intelligence, excelling in machine learning and deep learning. Our vision is to drive excellence and leadership in Canada's knowledge, creation, and use of AI to foster economic growth and improve the lives of Canadians. The Vector Institute is funded by the Province of Ontario, the Government of Canada through the Pan-Canadian AI Strategy administered by CIFAR, and industry sponsors from across the Canadian economy.

MaRS Centre, West Tower
661 University Ave., Suite 710
Toronto, ON M5G 1M1
vectorinstitute.ai ↗